



Cellspin[®] III LAB CYTOCENTRIFUGES

FOR THE PRODUCTION OF

- > Thin-layer cell preparations
- > Monolayer cell preparations



THARMAC® *Cellspin*® III

THE VERSATILE THARMAC® *Cellspin*® III CENTRIFUGE FAMILY

Four convincing arguments:

- 
Precision work through individual programmability of speed, acceleration, braking power and time.
- 
 No other comparable centrifuge is as **versatile, compatible** and offers you the performance range of the *Cellspin*® III family!
- 
Highest usability developed by the specialists of THARMAC® with decades of experience in centrifugation and cytology.
- 
State-of-the-art microprocessor-controlled **technology** ensures your safety and the highest possible quality in the results.

Cellspin® III centrifuges: a high-performance product of THARMAC®, Germany

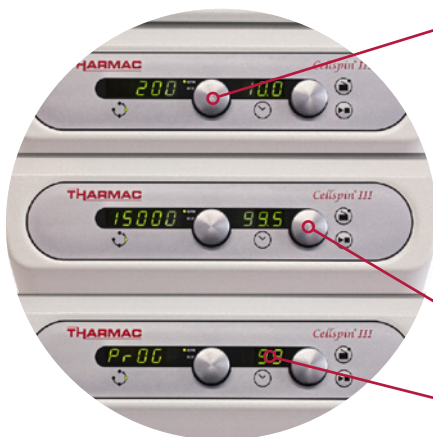

PRECISE WORKING:

- > **Minimal speed 200 rpm**
- > Maximum speed 2,000 rpm (CYTO), 15,000 rpm (LAB, UNI)
- > **10 braking levels** (more than any other comparable centrifuge)
- > **10 acceleration levels** (more than any other comparable centrifuge)
- > Speed individually adjustable in 10-RPM steps
- > **Individual time setting** from 0.1 to 99.5 minutes and continuous centrifugation
- > **100 individually programmable memory slots**



VERSATILE AND COMPATIBLE:

- › Making of Cellblocks (UNI and LAB) without expensive special equipment possible!
- › Cytoblock kits can be processed easily
- › Wide variety of rotors available (Cyto-rotors with 4, 8 and 12 positions)
- › **Compatible with Shandon™ Cytospin™ accessories and materials**
- › For human medical and veterinary diagnostics
- › Suitable for volumes up to 4 x 200 ml or 12 x 5 ml (CYTO)
- › High sample throughput possible - **can process up to 24 cytological samples at the same time** (with Double Cellfunnel®)

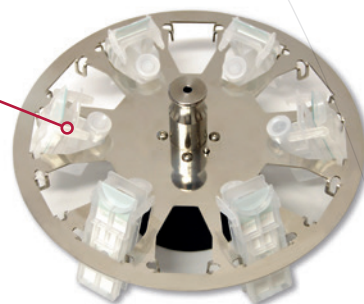

HIGHLY USER FRIENDLY:

- › User protection through zero carbon dust emission and a very safe metal case
- › Simple one-handed operation by ergonomic control panel
- › Automatic memory storage of the last setting
- › Autoclavable rotors
- › **Automatic rotor recognition**
- › Maintenance-free according to DGUV100-500
- › Closed rotors for even more safety
- › Impulse centrifugation
- › **Rotor change within seconds** thanks Quickchange
- › Smooth, easy to clean surfaces
- › Choice between RPM and RCF
- › Outstanding design through the participation of a multiple **Red Dot Award winning** design studio

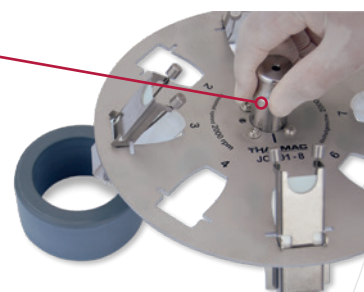



OUTSTANDING TECHNOLOGY:

- > Imbalance sensor
- > Parameter display during the run
- > 4 sensors to monitor safe working
- > **Microprocessor controlled, high precision run**
- > Stainless steel centrifugation chamber
- > **Expandable at any time**
- > Emergency lid release
- > Lid lock during the run
- > **Optimal stability** due to heavy design
- > Brushless drive

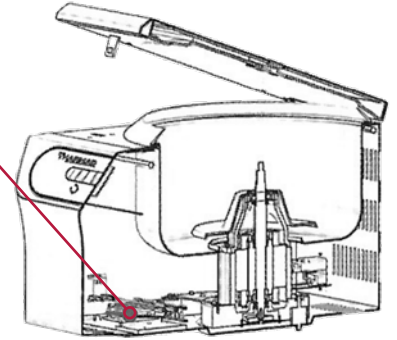

Cellspin[®] III LAB



- > The reliable basic device for every laboratory. Versatile rotor selection, a wide speed range with fine speed gradation and 100 program slots make the *Cellspin*[®] III the ideal multi-purpose centrifuge in each laboratory.
- > Speed range: 200 - 15,000 rpm
- > Sample volume: up to 4x 200 ml
- > Applicable rotors: swing-out, angle and hematocrit rotors
- > CE- and IVD-certified



THARMAC® *Cellspin*® III

Cellspin® III LAB

Laboratory centrifuge









Item no.	Item
3300-220	<i>Cellspin</i> ® III LAB, 220 V
3300-110	<i>Cellspin</i> ® III LAB, 115 V

ROTORS AND ACCESSORIES

Item no.	Item
3800-S1	Four place swing-out rotor (max. 4.400 RPM, capacity 4x 200ml)
3800-S1-100	Bucket, round, 200 ml (set of 4)
3800-S1-101	Cover for 200 ml bucket (set of 4)
3800-S1-010	Insert for 3x 15 ml conical tubes (set of 4)
3800-S1-020	Insert for 1x 50 ml conical tube (set of 4)
3800-S1-030	Insert for 12 open tubes 5 ml (set of 4)
3800-S1-040	Insert for 6 blood collection tubes 5-7 ml (set of 4)
3800-S1-050	Insert for 7 BD & Greiner collection tubes 5-7 ml (set of 4)
3800-S1-060	Insert for 9 Terumo / FACS collection tubes 5-7 ml (set of 4)
3800-S1-070	Insert for 6 collection tubes 10 ml (set of 4)
3800-S1-080	Insert for 7 BD collection tubes 10 ml (set of 4)
3800-S1-090	Insert for 30ml skirted tube (set of 4)

In the price list of *Cellspin* III LAB you will find further rotors and accessories, e.g. swing-out rotor, angle rotor, PCR angle rotor and hematocrit rotor with scale.

PERFORMANCE DATA OF *Cellspin® III* -CENTRIFUGES

<i>Cellspin® III</i> -Model	LAB 	CYTO 	UNIVERSAL 
Application area			
Laboratory in general	✓	-	✓
Cytology	-	✓	✓
Performance data			
Speed range, RPM	200 - 15.000 RPM	200 - 2.000 RPM	200- 15.000 RPM (auto. limit to 2,000 when using cyto-rotors)
Sample volume			
General laboratory use	max. 4x 200 ml	-	max. 4x 200 ml
Max. no. of cyto samples per run (depending on rotor)	48	-	48
Cytology	-	0,1 - 5 ml pro Rotorplatz, max. 60 ml pro Lauf	0,1 - 5 ml pro Rotorplatz, max. 60 ml pro Lauf
Max. no. of cyto samples per run (depending on rotor)	-	24	24
Operation			
Number of memory slots	100	100	100
Rotor recognition	✓	✓	✓
Quickchange for fast rotor change possible	-	✓	✓
Steps speed setting / RPM	d = 10	d = 10	d = 10
Acceleration levels / Braking levels	10 / 10	10 / 10	10 / 10
Centrifugation time (d = 0,1)	0,1 - 99,5 min	0,1 - 99,5 min	0,1 - 99,5 min
Impulse centrifugation	✓	✓	✓
Change betw. RCF and RPM display possible	✓	✓	✓
Maint.-free according to DGUV100-500	✓	✓	✓
Rotor variety	9 sedimentation rotors	11 cyto-rotors	9 sedimentation rotors 11 cyto-rotors
Safety			
Solid metal case and lid	✓	✓	✓
Automatic lid lock during the run	✓	✓	✓
Emergency lid release	✓	✓	✓
Stainless steel centrifugation chamber	✓	✓	✓
Automatic imbalance shutdown	✓	✓	✓
Motor overheating protection	✓	✓	✓
Complies with IEC1010, EN 61010-1:2010 EN 61010-2-020:2006	✓	✓	✓
Technical specifications			
Weight (w/o rotor) / Dimensions (W x D x H)	32 kg/ 405 x 500 x 325 mm		
Available with 230V/50-60Hz or 115V/50-60Hz	✓	✓	✓
Certification	CE 	CE 	CE 



THARMAC® GmbH Laboratory Solutions

Commercial unit

Hasselborner Straße 19-21 » DE-35647 Waldsolms » PHONE: +49 (0) 6085 98 99 1-0
FAX: +49 (0) 6085 98 99 1-19 » MAIL: info@tharmac.de

Place of business

Borsigstraße 7A » DE-65205 Wiesbaden » PHONE: +49 (0) 6122 5 88 97-33
FAX: +49 (0) 6122 5 88 97-36 » MAIL: info@tharmac.de