

CLEVER SOLUTIONS AT AFFORDABLE PRICES

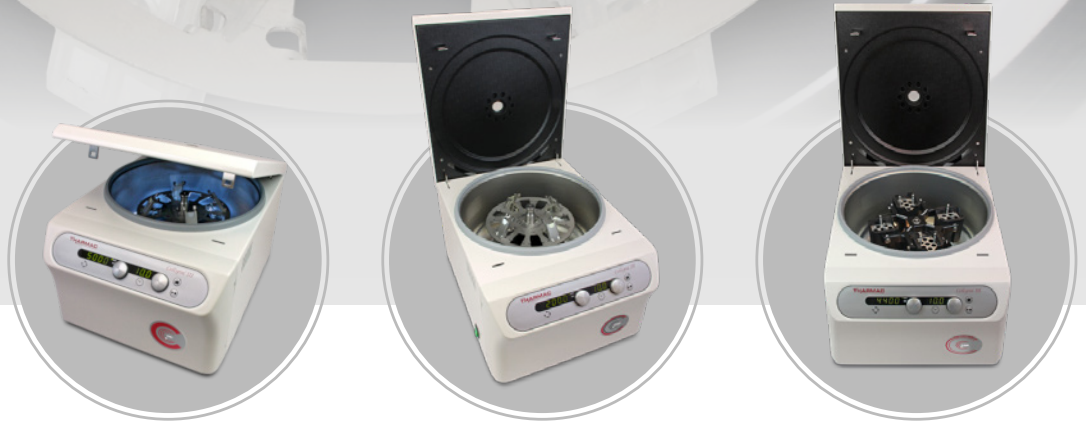

## *Cellspin*<sup>®</sup> III CYTO CYTOCENTRIFUGES

FOR THE PRODUCTION OF

- > Thin-layer cell preparations
- > Monolayer cell preparations



# THARMAC® *Cellspin*® III

## THE VERSATILE THARMAC® *Cellspin*® III CENTRIFUGE FAMILY

### Four convincing arguments:

- 
**Precision work** through individual programmability of speed, acceleration, braking power and time.
- 
 No other comparable centrifuge is as **versatile, compatible** and offers you the performance range of the *Cellspin*® III family!
- 
**Highest usability** developed by the specialists of THARMAC® with decades of experience in centrifugation and cytology.
- 
**State-of-the-art** microprocessor-controlled **technology** ensures your safety and the highest possible quality in the results.

*Cellspin*® III centrifuges: a high-performance product of THARMAC®, Germany

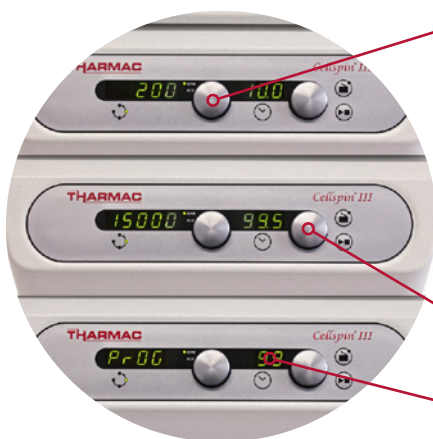

### PRECISE WORKING:

- > **Minimal speed 200 rpm**
- > **Maximum speed 2,000 rpm (CYTO), 15,000 rpm (LAB, UNI)**
- > **10 braking levels** (more than any other comparable centrifuge)
- > **10 acceleration levels** (more than any other comparable centrifuge)
- > **Speed individually adjustable in 10-RPM steps**
- > **Individual time setting** from 0.1 to 99.5 minutes and continuous centrifugation
- > **100 individually programmable memory slots**



### VERSATILE AND COMPATIBLE:

- › Making of Cellblocks (UNI and LAB) without expensive special equipment possible!
- › Cytoblock kits can be processed easily
- › Wide variety of rotors available (Cyto-rotors with 4, 8 and 12 positions)
- › **Compatible with Shandon™ Cytospin™ accessories and materials**
- › For human medical and veterinary diagnostics
- › Suitable for volumes up to 4 x 200 µl or 12 x 5 µl (CYTO)
- › High sample throughput possible - **can process up to 24 cytological samples at the same time** (with Double Cellfunnel®)



### HIGHLY USER FRIENDLY:

- › User protection through zero carbon dust emission and a very safe metal case
- › Simple one-handed operation by ergonomic control panel
- › Automatic memory storage of the last setting
- › Autoclavable rotors
- › **Automatic rotor recognition**
- › Maintenance-free according to DGUV100-500
- › Closed rotors for even more safety
- › Impulse centrifugation
- › **Rotor change within seconds** thanks Quickchange
- › Smooth, easy to clean surfaces
- › Choice between RPM and RCF
- › Outstanding design through the participation of a multiple **Red Dot Award winning** design studio

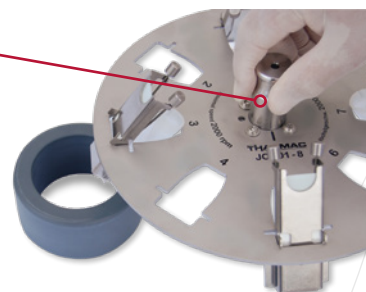



**OUTSTANDING TECHNOLOGY:**

- > Imbalance sensor
- > Parameter display during the run
- > 4 sensors to monitor safe working
- > **Microprocessor controlled, high precision run**
- > Stainless steel centrifugation chamber
- > **Expandable at any time**
- > Emergency lid release
- > Lid lock during the run
- > **Optimal stability** due to heavy design
- > Brushless drive

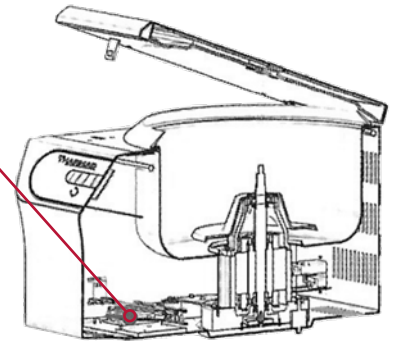

*Cellspin*<sup>®</sup> III CYTO



- > The specialist in cytology.  
Large selection on open and closed rotors -  
**also compatible with Shandon™ Cytospin™ systems.**  
Optionally with the rapid Quickchange rotor exchange system. Ideal for any cytological preparation.
- > Speed range: 200 - 2.000 RPM
- > Sample volume: 0,1 - 5 ml
- > Applicable rotors: cyto-rotors with 4, 8 and 12 positions
- > CE- and IVD-certified



# THARMAC® *Cellspin*® III

## *Cellspin*® III CYTO

Cytocentrifuges*	
Item no.	Item
3000-4-S	<i>Cellspin</i> ® III CYTO, with open, fixed 4-positions-rotor
3000-4-L	<i>Cellspin</i> ® III CYTO, with open, removable 4-positions-rotor
3000-4-G	<i>Cellspin</i> ® III CYTO, with closed, removable 4-positions-rotor
3000-8-S	<i>Cellspin</i> ® III CYTO, with open, fixed 8-positions-rotor
3000-8-L	<i>Cellspin</i> ® III CYTO, with open, removable 8-positions-rotor
3000-8-G	<i>Cellspin</i> ® III CYTO, with closed, removable 8-positions-rotor
3000-12-S	<i>Cellspin</i> ® III CYTO, with open, fixed 12-positions-rotor
3000-12-L	<i>Cellspin</i> ® III CYTO, with open, removable 12-positions-rotor
3000-12-G	<i>Cellspin</i> ® III CYTO, with closed, removable 12-positions-rotor
3000-12-EL	<i>Cellspin</i> ® III CYTO, with open, removable 12-positions EASY-rotor*, compatible with Shandon™ Cytospin™
3000-12-EG	<i>Cellspin</i> ® III CYTO, with closed, removable 12-positions EASY-rotor*, compatible with Shandon™ Cytospin™

\*Available with 230V/50-60 Hz or 115 V/50-60 Hz

### The following Starter Kits are included in the price and the shipment:

Optionally, either

#### Starter Kit with reusable Single Cellfunnel®:

- 4, 8 or 12 CellClips 302 (quantity according to selected rotor)
- 4, 8 or 12 reusable Single Cellfunnel® 304 (quantity according to selected rotor)
- 200 disposable filter cards 305
- 200 Cytoslides, coated, 311

For this Starter Kit with reusable Single Cellfunnel® please add "-R" to the order no of the centrifuge.

**Beispiel: 3000-8-L-R**

or

#### Starter Kit with disposable Single Cellfunnel®:

- 4, 8 or 12 CellClips 302 (quantity according to selected rotor)
- 200 disposable Single Cellfunnel® 320
- 200 Cytoslides, coated, 311

For this Starter Kit with disposable Single Cellfunnel® please add "-D" to the order no of the centrifuge.







**Beispiel: 3000-8-L-D**

When ordering an Easy Rotor, the starter kit is included accordingly.  
Stainless steel clips 390 instead of 302. compatible with Shandon™ Cytospin™.

All removable Tharmac CellClip-rotors have the Tharmac Quickchange system that allows a rotor change within seconds.

\*\*for *Cellspin*® III CYTO only, cannot be used with *Cellspin*® I or *Cellspin*® II!

# PERFORMANCE DATA OF *Cellspin® III* -CENTRIFUGES

<i>Cellspin® III</i> -Model	LAB 	CYTO 	UNIVERSAL 
<b>Application area</b>			
Laboratory in general	✓	-	✓
Cytology	-	✓	✓
<b>Performance data</b>			
Speed range, RPM	200 - 15.000 RPM	200 - 2.000 RPM	200- 15.000 RPM (auto. limit to 2,000 when using cyto-rotors)
<b>Sample volume</b>			
General laboratory use	max. 4x 200 ml	-	max. 4x 200 ml
Max. no. of cyto samples per run (depending on rotor)	48	-	48
Cytology	-	0,1 - 5 ml pro Rotorplatz, max. 60 ml pro Lauf	0,1 - 5 ml pro Rotorplatz, max. 60 ml pro Lauf
Max. no. of cyto samples per run (depending on rotor)	-	24	24
<b>Operation</b>			
Number of memory slots	100	100	100
Rotor recognition	✓	✓	✓
Quickchange for fast rotor change possible	-	✓	✓
Steps speed setting / RPM	d = 10	d = 10	d = 10
Acceleration levels / Braking levels	10 / 10	10 / 10	10 / 10
Centrifugation time (d = 0,1)	0,1 - 99,5 min	0,1 - 99,5 min	0,1 - 99,5 min
Impulse centrifugation	✓	✓	✓
Change betw. RCF and RPM display possible	✓	✓	✓
Maint.-free according to DGUV100-500	✓	✓	✓
<b>Rotor variety</b>	9 sedimentation rotors	11 cyto-rotors	9 sedimentation rotors 11 cyto-rotors
<b>Safety</b>			
Solid metal case and lid	✓	✓	✓
Automatic lid lock during the run	✓	✓	✓
Emergency lid release	✓	✓	✓
Stainless steel centrifugation chamber	✓	✓	✓
Automatic imbalance shutdown	✓	✓	✓
Motor overheating protection	✓	✓	✓
Complies with IEC1010, EN 61010-1:2010 EN 61010-2-020:2006	✓	✓	✓
<b>Technical specifications</b>			
Weight (w/o rotor) / Dimensions (W x D x H)	32 kg/ 405 x 500 x 325 mm		
Available with 230V/50-60Hz or 115V/50-60Hz	✓	✓	✓
Certification	CE 	CE 	CE 

CLEVER SOLUTIONS AT AFFORDABLE PRICES



**THARMAC® GmbH**

Im Dachsstück 15 » DE-65549 Limburg an der Lahn » PHONE: +49 (0) 6431 5 84 88-0  
FAX: +49 (0) 6431 5 84 88-28 » MAIL: [info@tharmac.de](mailto:info@tharmac.de)