

CLEVER SOLUTIONS AT AFFORDABLE PRICES



Cellspin[®] III UNIVERSAL CYTOCENTRIFUGES

FOR THE PRODUCTION OF

- > Thin-layer cell preparations
- > Monolayer cell preparations



THARMAC® *Cellspin*® III

THE VERSATILE THARMAC® *Cellspin*® III CENTRIFUGE FAMILY

Four convincing arguments:

-  **Precision work** through individual programmability of speed, acceleration, braking power and time.
-  No other comparable centrifuge is as **versatile, compatible** and offers you the performance range of the *Cellspin*® III family!
-  **Highest usability** developed by the specialists of THARMAC® with decades of experience in centrifugation and cytology.
-  **State-of-the-art** microprocessor-controlled **technology** ensures your safety and the highest possible quality in the results.

Cellspin® III centrifuges: a high-performance product of THARMAC®, Germany

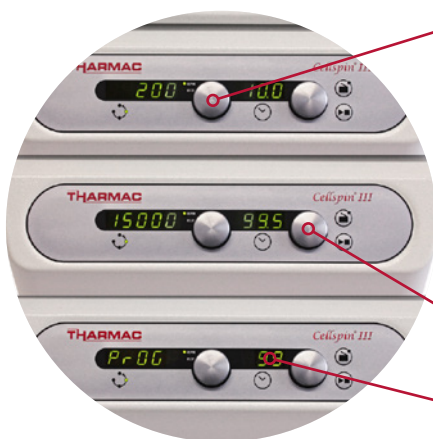

PRECISE WORKING:

- > **Minimal speed 200 rpm**
- > Maximum speed 2,000 rpm (CYTO), 15,000 rpm (LAB, UNI)
- > **10 braking levels** (more than any other comparable centrifuge)
- > **10 acceleration levels** (more than any other comparable centrifuge)
- > Speed individually adjustable in 10-RPM steps
- > **Individual time setting** from 0.1 to 99.5 minutes and continuous centrifugation
- > **100 individually programmable memory slots**



VERSATILE AND COMPATIBLE:

- › Making of Cellblocks (UNI and LAB) without expensive special equipment possible!
- › Cytoblock kits can be processed easily
- › Wide variety of rotors available (Cyto-rotors with 4, 8 and 12 positions)
- › **Compatible with Shandon™ Cytospin™ accessories and materials**
- › For human medical and veterinary diagnostics
- › Suitable for volumes up to 4 x 200 ml or 12 x 5 ml (CYTO)
- › High sample throughput possible - **can process up to 24 cytological samples at the same time** (with Double Cellfunnel®)

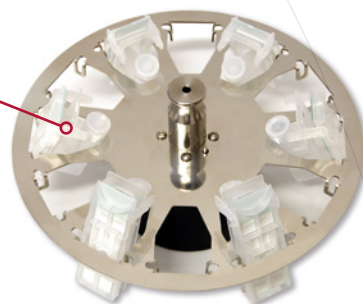

HIGHLY USER FRIENDLY:

- › User protection through zero carbon dust emission and a very safe metal case
- › Simple one-handed operation by ergonomic control panel
- › Automatic memory storage of the last setting
- › Autoclavable rotors
- › **Automatic rotor recognition**
- › Maintenance-free according to DGUV100-500
- › Closed rotors for even more safety
- › Impulse centrifugation
- › **Rotor change within seconds** thanks Quickchange
- › Smooth, easy to clean surfaces
- › Choice between RPM and RCF
- › Outstanding design through the participation of a multiple **Red Dot Award winning** design studio

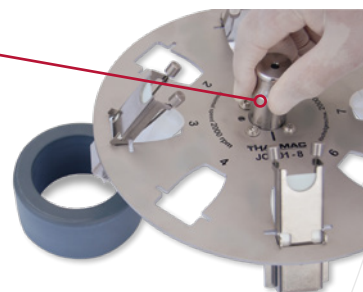



OUTSTANDING TECHNOLOGY:

- > Imbalance sensor
- > Parameter display during the run
- > 4 sensors to monitor safe working
- > **Microprocessor controlled, high precision run**
- > Stainless steel centrifugation chamber
- > **Expandable at any time**
- > Emergency lid release
- > Lid lock during the run
- > **Optimal stability** due to heavy design
- > Brushless drive

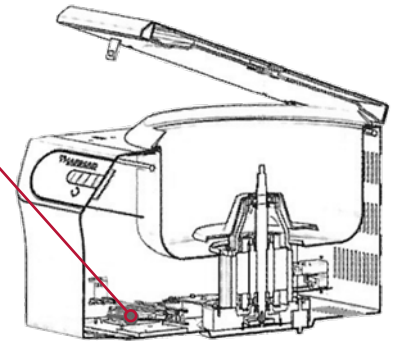

Cellspin® III UNIVERSAL



- > The genius among the centrifuges.
- > **Automatic rotor detection and speed adjustment** on max. 2,000 rpm when using cytorotors!
Huge rotor selection. No reprogramming required!
- > Speed range: 200 - 15,000 rpm
- > Sample volume: 0.1 - 5 ml (cytology), up to 4x 200 ml (standard laboratory use)
- > Applicable rotors: swing out-, angle- as well as hematocrit-rotors **and** cyto-rotors - **also compatible with Shandon™ Cytospin™ systems**
- > CE- and IVD-certified



THARMAC® *Cellspin*® III

Cellspin® III UNIVERSAL

Universal centrifuges*

Item no.	Item
3200-220	<i>Cellspin</i> ® III UNI, 220 V
3200-110	<i>Cellspin</i> ® III UNI, 115 V



The basic price of *Cellspin*® III Universal includes 1x 4-position open, screwed cyto-rotor (Art.nr. 3900-4-S) and 1x angle rotor for Falcon tubes (Art.nr. 3800-A2) as standard. On request, you can combine the device with any other combination of 1x cyto-rotor and order 1x laboratory rotor. You can find the other combinations in the price list. In this case, the prices indicated with ² will be added to or subtracted from the basic price. For each additional rotor, the standard rotor prices listed with ¹ apply.

The following Starter Kits are included in the price and the shipment:

Optionally, either

Starter Kit with reusable Single Cellfunnel®:

- 4, 8 or 12 CellClips 302 (quantity according to selected rotor)
- 4, 8 or 12 reusable Single Cellfunnel® 304 (quantity according to selected rotor)
- 200 disposable filter cards 305
- 200 Cytoslides, coated, 311

Starter Kit with disposable Single Cellfunnel®:







- 4, 8 or 12 CellClips 302 (quantity according to selected rotor)
- 200 disposable Single Cellfunnel® 320
- 200 Cytoslides, coated, 311

Please indicate in your order which starter kit you want.

When ordering an Easy Rotor, the starter kit is included accordingly.
Stainless steel clips 390 instead of 302. compatible with Shandon™ Cytospin™.

In the price list of *Cellspin*® III Universal you will find further rotors and accessories, e.g. swing-out rotor, angle rotor, PCR angle rotor and haematocrit rotor with scale.

PERFORMANCE DATA OF *Cellspin® III* -CENTRIFUGES

<i>Cellspin® III</i> -Model	LAB 	CYTO 	UNIVERSAL 
Application area			
Laboratory in general	✓	-	✓
Cytology	-	✓	✓
Performance data			
Speed range, RPM	200 - 15.000 RPM	200 - 2.000 RPM	200- 15.000 RPM (auto. limit to 2,000 when using cyto-rotors)
Sample volume			
General laboratory use	max. 4x 200 ml	-	max. 4x 200 ml
Max. no. of cyto samples per run (depending on rotor)	48	-	48
Cytology	-	0,1 - 5 ml pro Rotorplatz, max. 60 ml pro Lauf	0,1 - 5 ml pro Rotorplatz, max. 60 ml pro Lauf
Max. no. of cyto samples per run (depending on rotor)	-	24	24
Operation			
Number of memory slots	100	100	100
Rotor recognition	✓	✓	✓
Quickchange for fast rotor change possible	-	✓	✓
Steps speed setting / RPM	d = 10	d = 10	d = 10
Acceleration levels / Braking levels	10 / 10	10 / 10	10 / 10
Centrifugation time (d = 0,1)	0,1 - 99,5 min	0,1 - 99,5 min	0,1 - 99,5 min
Impulse centrifugation	✓	✓	✓
Change betw. RCF and RPM display possible	✓	✓	✓
Maint.-free according to DGUV100-500	✓	✓	✓
Rotor variety	9 sedimentation rotors	11 cyto-rotors	9 sedimentation rotors 11 cyto-rotors
Safety			
Solid metal case and lid	✓	✓	✓
Automatic lid lock during the run	✓	✓	✓
Emergency lid release	✓	✓	✓
Stainless steel centrifugation chamber	✓	✓	✓
Automatic imbalance shutdown	✓	✓	✓
Motor overheating protection	✓	✓	✓
Complies with IEC1010, EN 61010-1:2010 EN 61010-2-020:2006	✓	✓	✓
Technical specifications			
Weight (w/o rotor) / Dimensions (W x D x H)	32 kg/ 405 x 500 x 325 mm		
Available with 230V/50-60Hz or 115V/50-60Hz	✓	✓	✓
Certification	CE 	CE 	CE 

CLEVER SOLUTIONS AT AFFORDABLE PRICES



THARMAC® GmbH

Im Dachsstück 15 » DE-65549 Limburg an der Lahn » PHONE: +49 (0) 6431 5 84 88-0
FAX: +49 (0) 6431 5 84 88-28 » MAIL: info@tharmac.de